

# Isokern Vent-Free 42" Fireplace

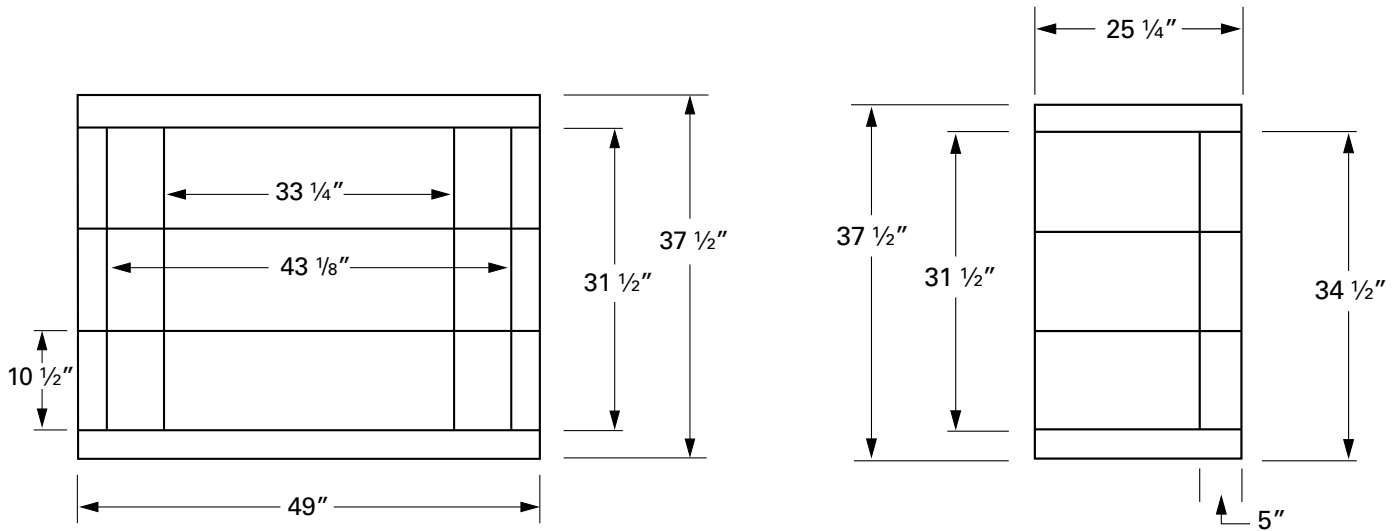

6899 Phillips Industrial Blvd. • Jacksonville, FL 32256

Project Name: \_\_\_\_\_ Location: \_\_\_\_\_



**Front View**

**Side View**

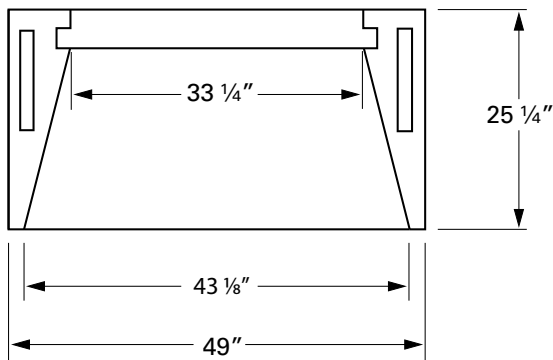

**Plan View**

## MINIMUM FRAMING DIMENSIONS

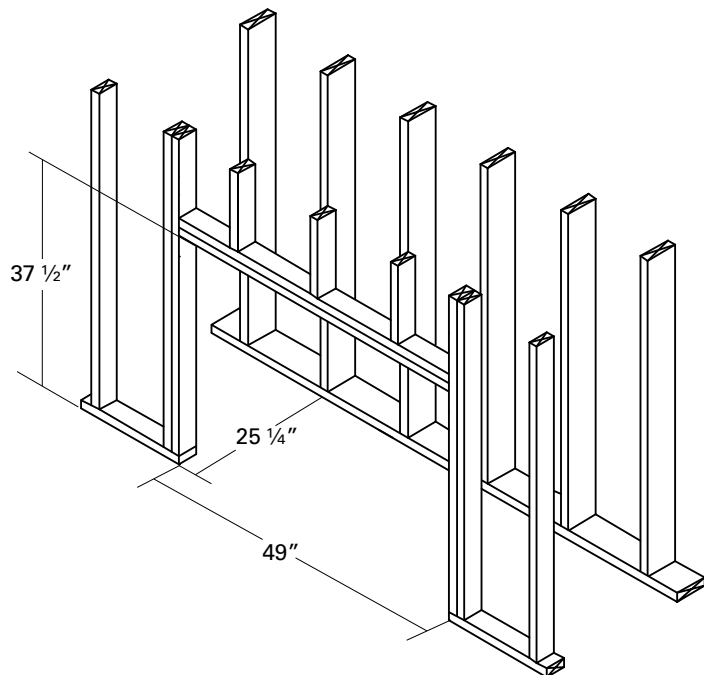

### FIREPLACE OPTIONS

Hearth Height: \_\_\_\_\_

Brick Type: \_\_\_\_\_

Brick Color: \_\_\_\_\_

Brick Pattern: \_\_\_\_\_

Vent Free Log Set: \_\_\_\_\_

Notes: \_\_\_\_\_

\_\_\_\_\_

\_\_\_\_\_

\_\_\_\_\_

The total weight for the Vent-Free 42" fireplace is approximately 820 lbs. This dry weight includes fireplace pumice components only, additional weight from mortar and firebrick not included.